



DUCT-O-WIRE

INSTALLATION & OPERATION

MANUAL

RC-P1M1

RC-P2M1

RC-P3M1

SEPTEMBER, 2018

*FCC ID: NCTSAGA1-L8
IC: 2802A-SAGA1L8
CE 0470*

This device complies with part 15 of FCC rules. Operations is subject to the following two conditions: (1) this device may not cause harmful interference, and (2) this device must accept any interference received, including interference that may cause undesired operation.

*ATTENTION:
PLEASE BE SURE TO VERIFY THAT YOU HAVE
PURCHASED THE CORRECT SYSTEM FOR YOUR
APPLICATION.*

*ANY MODIFICATION OF THE SYSTEM WILL RE-
SULT IN ADDITIONAL RESTOCKING FEES OR
DENIAL OF RETURN*

Limited Warranty

Duct-O-Wire guarantees that this product meets its published specification at the time of shipment from the factory. This equipment will perform as described if properly installed. However, Duct-O-Wire cannot guarantee that the operation of these units is absolutely error-free, or without interruption.

This equipment is warranted against defects in materials and workmanship for a period of 2 years from the date of shipment. During the warranty period, Duct-O-Wire is responsible for necessary repairs, as long as the product can be proved to be defective.

For warranty service, this product must be returned to our factory. Customer is responsible for shipping charges to Duct-O-Wire., while Duct-O-Wire will pay return shipping charges.

This warranty does NOT include consumable parts, such as batteries, fuses, buttons, and relays or damage from normal wear and tear. Also this warranty does NOT cover defects caused by misuse, neglect, accident, unauthorized modification, failure to follow instructions, improper installation, improper or insufficient maintenance, unsuitable operating environments, acts of God, improper operation, ignorance of environmental specifications, fire, or improper software settings.

If your Duct-O-Wire product fails to work as warranted above, Duct-O-Wires maximum liability under this limited warranty is expressly limited to the lesser of the price you have paid for the product. Duct-O-Wire disclaims any liability as a result of any direct/indirect, special, incidental or consequential damages.

No other warranty is expressed or implied, except for the above mentioned.

Operating Precautions

- ◇ Read this manual carefully before operating and in stalling the Pocket system.
(This Manual is for reference only.)
- ◇ This equipment has been tested at the factory under normal operating conditions.
- ◇ After operation please turn off main power to crane and the power to Receiver.
- ◇ The Crane should be equipped with main power Relay, Limit Switch and other required safety devices.
- ◇ Never use this device during an electrical storm, or high electrical interference conditions.
- ◇ Do not use rechargeable batteries in transmitters.
- ◇ Always turn off power when installing or providing maintenance on unit.
- ◇ Contents of the Manual may be amended by Duct-O-Wire without notice.
- ◇ Duct-O-Wire may change functions or new functions may come available and as a result description of units may change.
- ◇ Never operate these systems under extremely hazardous conditions/situations or where damage may occur.

Precautions

- ◇ After Operating the Pocket series, please press EMS to shut off main power to the Crane & Receiver.
- ◇ Never continue operating the crane when slow-response occurs.
- ◇ Only qualified personal should operate this equipment.
- ◇ The Pocket Series has a rating of IP65. Only use under these conditions/rating.
- ◇ Always inspect transmitters before operation.
- ◇ Incase of emergency press the EMS button.
- ◇ Remove batteries when crane is not in use for an extended period of time.
- ◇ Operator must be familiar with Emergency Procedures before operating.

Standard Accessories for the Pocket series.

RC-P1M1

RC-P2M1

RC-P3M1

2 Transmitters



1 Receiver



Specifications

1. Enclosure: IP65
2. Structure: Glass Fiber
3. Operating Temp: -45-+80°C
4. Relay: 5A/250VAC (AC Power)
10A/36VDC (DC Power)
5. ID Code: 32bit
6. Hamming Distance ≥ 4
7. Static >15KV
8. ID Code Registration
9. Operating range: up to 300 feet

Pocket Series Transmitter

- ◆ RC-P1M1 1 MOTION 1 SPEED WITH ON/OFF
- ◆ RC-P2M1 2 MOTION 1 SPEED WITH ON/OFF
- ◆ RC-P3M1 3 MOTION 1 SPEED WITH ON/OFF



RC-P1M1



RC-P2M1

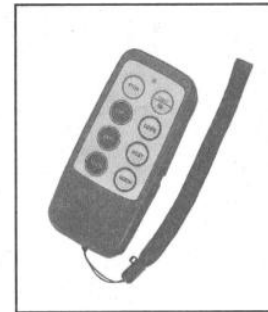

RC-P3M1

1. LxWxH: 4.72"x2.17"x.98"
2. Weight: .34lbs
3. 2 AA size alkaline batteries
4. Low power indicator (LED flash Red)
5. Pushbutton Jammed detector
6. Shock resistance
7. Output power $\leq 4\text{mW}$
8. Normal power consumption <10mA
9. Sleep mode consumption: less $1\mu\text{A}$
10. Modulation: FM

Pocket Series Receiver



1. LxWxH: 6.33"x2.91"x2.04"
2. Weight :2.5lbs (w/out cable)
3. AC type:
24/48,48/110,48/220,110/220
220/380VAC
DC Type: 12V-24VDC
4. Sensitivity: about 105dBm
5. Shock resistance
6. Independent COM line
6-1 4 independent COM line U/D,
E/W,S/N RO for RC-P3M1
6-2 3 independent COM line U/D,
E/W,RO for RC-P2M1
6-3 2 independent COM line U/D,
RO for RC-P1M1

EMERGENCY PROCEDURES

If case of emergency please:

- ◆ Press the STOP button
- ◆ Switch off the main power to the crane

Press Stop Button

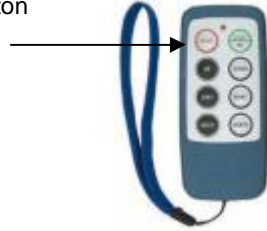

General Operation

- ◆ Turn on the main power switch on the crane.
 - ◆ Install two AA size Alkaline batteries in the transmitter
 - ◆ Press the Start/RO pushbutton to turn on the main relay inside receiver.
 - ◆ Operate normally
- **After operation**
- ◆ Press the STOP button
 - ◆ Put the transmitter in a safe place
 - ◆ Switch off the main power to crane



← Press the Start/RO button
to turn on main relay inside Receiver

Receiver Voltage Selection

There are two types of power voltage (DC AND AC)
Available for the Pocket series.

1 DC TYPE:

Input voltage: 12-24VDC
Relay contact 10A-36VDC

2 AC TYPE:

5 different transformers:
24/48V, 48, 110V, 48/220V, 110, 220V, 220/380V

The voltage selection jumper is:

	LO	HI
AC24/48V (TRANSFORMER)	24	48
AC48/110V (TRANSFORMER)	48	110
AC48/220V (TRANSFORMER)	48	220
AC110/220V (TRANSFORMER)	110	220
AC220/380V (TRANSFORMER)	220	380

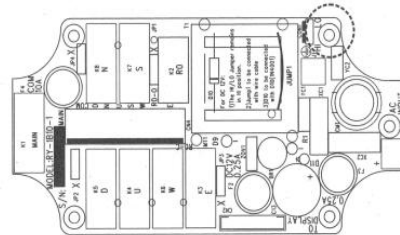
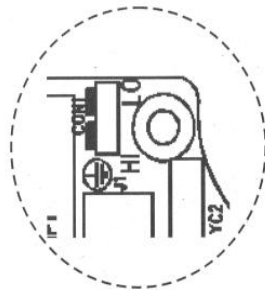

Changing Fuse

- ◆ DC Type
Unplug the yellow 20A fuse and replace

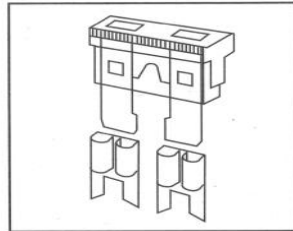

- ◆ AC Type
Depress the fuse cover and turn counter-clockwise with a flat head screwdriver to open up the fuse cover. Remove old fuse and insert correct fuse into the cover. Place this fuse along with cover into the fuse holder base. Depress the fuse cover and turn clockwise with flat head screwdriver.

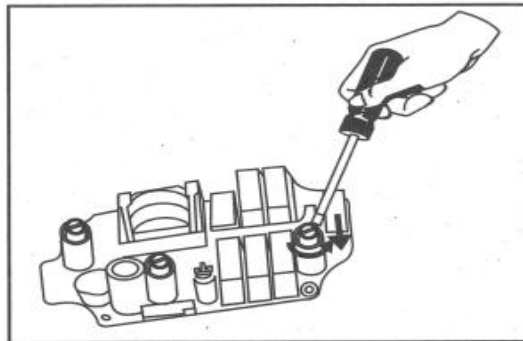

ID-Code Remote Setting

ID Registration allows you to pair the new TX or RX if one of them is damaged. In order to work the TX & RX must have the same ID codes and frequency. Using ID Registration will make both the TX and RX to have the same ID codes.

Please make sure of the following conditions before setting the ID Registration

- ◆ Both TX and RX are of the Same model and frequency.
- ◆ To place transmitter as close as possible to the receiver to avoid any interference.
- ◆ Turn off the RX power more than 10 seconds and turn it on again.
- ◆ Complete the ID Registration within 4 minutes after turning on the RX. The RX will NOT accept the ID Registration signal after 4 minutes.

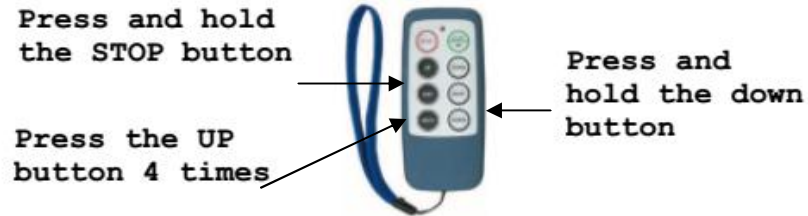

ATTENTION:

- ◆ In case ID Registration fails, repeat the instructions above within 4 minutes.
- ◆ ID Registration is available for ID code only. It will not change function settings.
- ◆ Within the operating distance, all same systems on the same frequency will be paired with the transmitters ID code.

Changing the Frequency

It is easy to change the frequency of the pocket series simply by replacing corresponding frequency crystals in both the Transmitter and the Receiver.

- **Note: To replace a new crystal, please note that there are two kinds of frequencies (VHF and UHF) available. The indication of VHF or UHF is shown on the PC board with a check mark “V”. Please make sure not to replace a VHF crystal unit into a UHF PC board, or vice versa.**

Instructions:

1. Pry up the crystal unit with a flathead screwdriver.
2. Remove the crystal unit from the system.
3. Use needle nose pliers to straighten both pins of the new crystal unit.
4. Insert the new crystal unit vertically into the PC board.
5. Press the new crystal unit down into the socket.

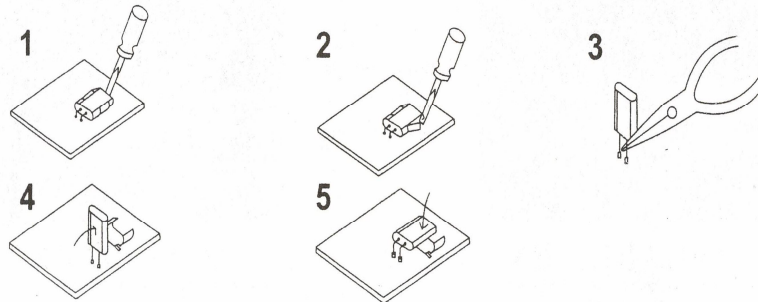

! ATTENTION!

The Transmitter frequency will be different from the Receiver frequency. The transmitter crystals are labeled T01 thru T45 and the receiver crystals are labeled R01 thru R45

Batteries

Two AA size alkaline batteries are required for the Transmitter.

The LED will flash green when the battery power is sufficient.

The LED will flash red when the battery power is low.

- The operating distance will become shorter and intermittent when the battery is low.
- Replace with new battery when battery power is low.

! DO NOT USE RECHARGEABLE BATTERIES

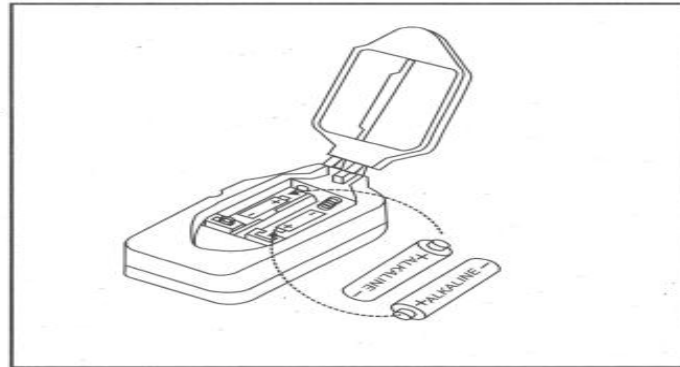

LED ALERT

If a problem listed below is found please contact us

Red LED flashes quickly (.2 sec) when any pushbutton is pressed.

The problem may be:

1. One of the pushbuttons may be jammed.
2. The system is not properly powered.

TX LED flashes slowly (.5 sec)

1. The memory of the transmitter is defective.

RX Error LED flashes slowly (.5 sec).

1. The memory of the receiver is defective

NOTES:

NOTES:

NOTES:



DUCT-O-WIRE
1351 W. Second Street
Oconomowoc, WI 53066
Phone: 262-567-2288
Fax: 262-567-0857

E-MAIL
Sales@ductowire.com
www.Ductowire.com

DUCT-O-WIRE
1445 Norjohn Ct. Unit 10
Burlington, Ontario, Canada
L7L 086
Phone: 905-331-2612
800-361-9473
Fax: 905-331-6639
800-663-0933